

UNIVERSAL ISOLATED HEAD TRANSMITTER THU301-I



The Tekon Electronics Universal Temperature In Head Transmitters are specifically designed to meet the most rigorous requirements of operation in the industrial process environments.

The THU301-I is an ultra-flexible universal temperature transmitter which accepts the most commonly used temperature sensors (Resistance thermometers with 2, 3 or 4-wire system and Thermocouples) and generates a linear 4 to 20mA current signal with high stability as output.

Dimensions 45Ø x 23 mm

Weight Approx. 50g

Material Nylon 66

Protection Index IP40

KEY FEATURES

PT100, PT500 AND PT1000 INPUT SENSOR

THERMOCOUPLE SENSOR INPUT

B, J, K, N, R, S, T

1,5 kV AC GALVANIC ISOLATION

4 TO 20 mA ANALOG OUTPUT

2 STATUS LEDS

HIGH MEASUREMENT ACCURACY

HIGH EMC PERFORMANCE

NAMUR NE 43 FAULT COMPLIANT

CONFIGURABLE OVER PC

TEKON CONFIGURATOR SOFTWARE

DS_INHD_THU301-I-E01C

TECHNICAL SPECIFICATIONS

**INPUT
RESISTANCE THERMOMETER (RTD)**

Measured variable	Temperature
Sensor type ¹	PT100, PT500, PT1000
Connection ²	1 Resistance thermometer (RTD) in 2, 3 and 4-wire system
Units	°C
Sensor current	200 µA
Open-circuit monitoring	Always active (cannot be disabled)
Short-circuit monitoring	Always active (cannot be disabled)
Measuring range	Configurable (see "Digital measuring accuracy" table)
Minimum measured span	50°C
Characteristic curve	Temperature-linear
Cable resistance per wire (max.)	50 Ω
Effect of sensor cable resistance	< 0,0015 Ω / Ω - 3 wires < 0,0005 Ω / Ω - 4 wires

**INPUT
THERMOCOUPLES (TC)**

Measured variable	Temperature
Sensor type ³	Thermocouples B, J, K, N, R, S, T
Units	°C
Connection	1 Thermocouple (TC)
Sensor current diagnostic	< 11 nA
Open-circuit monitoring	Always active (cannot be disabled)
Short-circuit monitoring	Not available
Cold junction compensation (CJC)	Integrated resistance thermometer
Measuring range	Configurable (see "Digital measuring accuracy" table)
Minimum measured span	50°C
Characteristic curve	Temperature-linear

OUTPUT

Output signal	4 to 20 mA
Power supply (U _{aux})	12 to 24V DC
Max. load	(U _{aux} - 12) / 0,021 A
Error signal (e.g. following sensor fault) (conforming to NAMUR NE43)	Software configurable 3,2mA or 21mA
Sample cycle	< 200ms
Protection	Against reversed polarity Surge protection

COMMON SPECIFICATIONS

Isolation voltage (test operation)	1,5 kV AC 48 V AC
Internal power dissipation	40 mW to 0,5 W
Voltage drop	12 VDC
Effect of supply voltage variation	< 0,003% of span/ V DC

Response time 90%	< 1s
Power-up time [TC]	< 600ms
Power-up time [RTD]	< 1s

MEASUREMENT ACCURACY

Reference conditions	
Auxiliary power	24V DC ± 1%
Ambient temperature	23°C
Warm-up time	2 min
Error in the analog output (digital/analog converter)	≤ ± 0,01% of span
Digital measuring errors	See table "Digital measuring accuracy" table
Error due to internal cold junction	< ± 0,35 °C
Influence of ambient temperature	
on RTD measurement	< ± 0,0042 °C / °C
on thermocouple	Thermocouples J, K, N: ≤ ± 0,0008 °C / °C Thermocouples B, R, S, T: ≤ ± 0,0012 °C / °C
on analog output	< ± 0,002% of span / °C
EMC - immunity influence (IEC 61326-1)	< ± 0,0891% of span
Extended EMC immunity (NAMUR NE 21, A criterion, burst)	< ± 0,63% of span

OPERATING ENVIRONMENT

Ambient temperature range	-40 to 80°C
Storage temperature range	-40 to 80°C
Relative humidity	≤95%, without condensation

FACTORY DEFAULT SETTINGS

Sensor	PT100 with 3-wire circuit
Measuring range	-200°C to 850°C
Temperature Format	Celsius [°C]
Fault current	3,2 mA
Current offset	0 μA

CASING

Material	Nylon 66
Weight	Approx. 50g
Dimensions	See "Dimensional drawings"
Cross section	2.5 mm ²
Protection type	IP40

CERTIFICATIONS AND APPROVALS

EN 61326-1- Class B - Industrial Requirements
IEC 61000-4-2
IEC 61000-4-3
IEC 61000-4-4

IEC 61000-4-5

IEC 61000-4-6

IEC 61000-4-8

¹ Devices with a firmware version equal to or less than "2.0.0" only supports PT100 sensors

² Devices with a firmware version equal to or less than "2.0.0" only supports 3-wire connection

³ Thermocouple B sensor input is only available for equipment with a firmware version equal to or higher than "3.1.0"

DIGITAL MEASURING ACCURACY

RESISTANCE THERMOMETER (RTD)

SENSOR	RANGE °C	DIGITAL ACCURACY °C
PT100	-200 to 850	< ± 0,2
PT500	-200 to 850	< ± 0,2
PT1000	-200 to 850	< ± 0,2

THERMOCOUPLES (TC)

SENSOR	RANGE °C	DIGITAL ACCURACY °C
B	0 to 1820	< ± 1
J	-210 to 1200	< ± 0,5
K	-270 to 1372	< ± 0,5
N	-270 to 1270	< ± 0,5
R	-50 to 1768	< ± 1
S	-50 to 1768	< ± 1
T	-270 to 400	< ± 0,5

TECHNICAL DRAWINGS AND INFORMATION

DIMENSIONAL DRAWINGS & INSTALLATION DIAGRAM

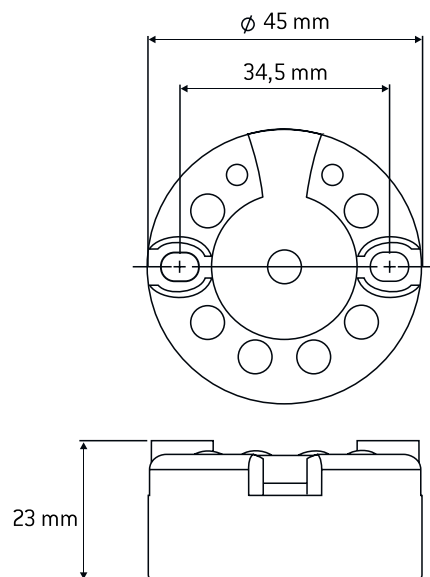

ELECTRICAL CONNECTIONS

POWER SUPPLY

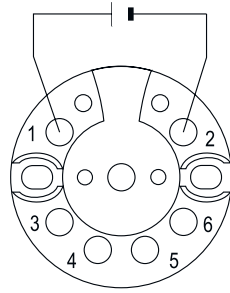

THERMOCOUPLE

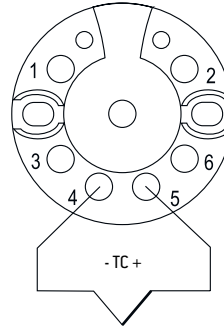

RESISTANCE THERMOMETER

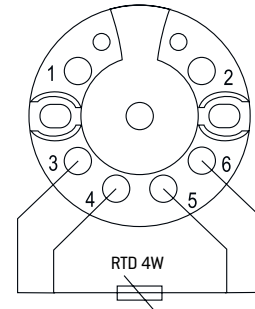
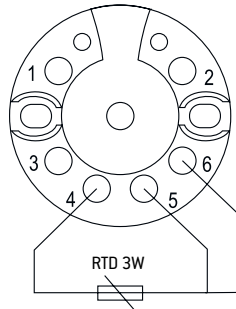
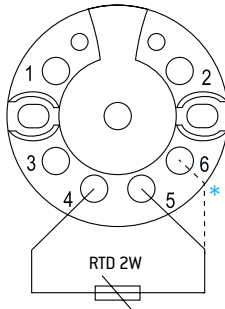

STATUS LED

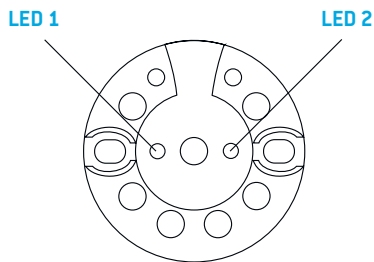

LED 1 (RED)	LED 2 (BLUE)	
OFF	BLINK	No sensor error Configuration mode
FLASH	BLINK	Sensor error Configuration mode
BLINK	BLINK	Temperature out of range Configuration mode
OFF	ON	No sensor error Normal mode
FLASH	ON	Sensor error Normal mode
BLINK	ON	Temperature out of range Normal mode

*The 2-wire connection requires an electrical connection between screw 5 and screw 6

BLOCK DIAGRAM

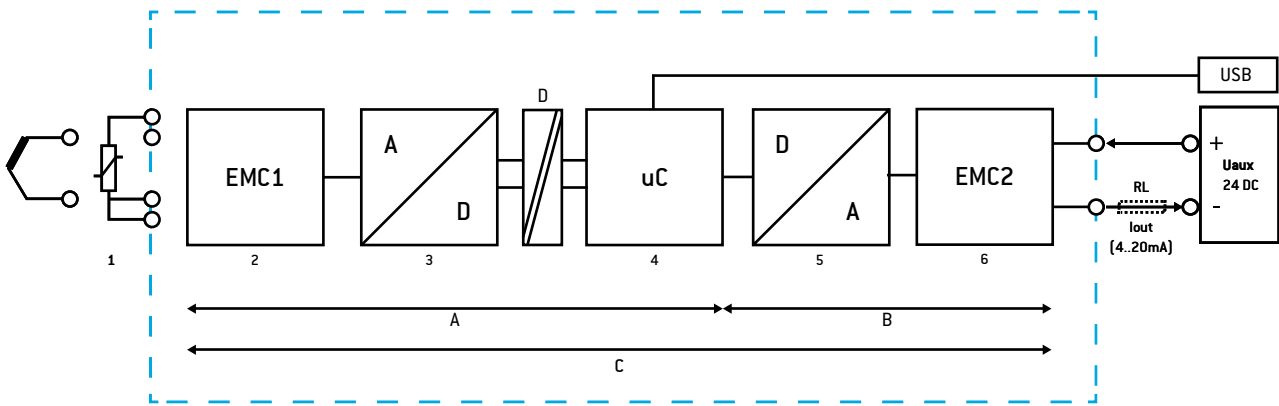

- 1 - Sensor (RTD, TC)
- 2 - Sensor input protection module
- 3 - Analog-Digital converter (16 Bits)
- 4 - Microcontroller
- 5 - Digital-Analog converter (16 bits)
- 6 - Output protection module

- RL - Loop load
- Uaux - Power supply
- Iout - Output current
- A - Digital measure accuracy
- B - Digital / Analog conversion accuracy
- C - Total measure accuracy
- D - Electrical isolation

REVISION HISTORY

VERSION	
E01B	Inclusion of PT500 and PT1000 sensor types, sensor cable resistance, electrical connections supported and isolation voltage values in different firmware versions.
E01C	Insertion of thermocouple B

TEKON ELECTRONICS
a brand of Bresimar Automação S.A.

Avenida Europa, 460
3800-230 Aveiro
PORTUGAL

P.: +351 234 303 320
M.: +351 933 033 250
E.: sales@tekonelectronics.com

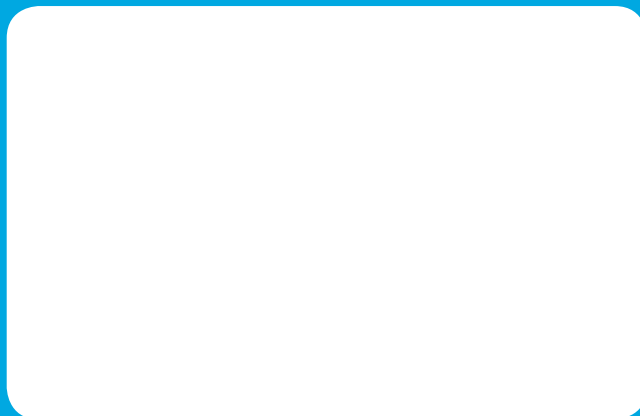

Cofinanciado por:



UNIÃO EUROPEIA
Fundo Europeu
de Desenvolvimento Regional